

1

2

3

4

5

6

RevNo

Revision note

Date

Signature

Checked

A

A

B

B

C

C

D

D

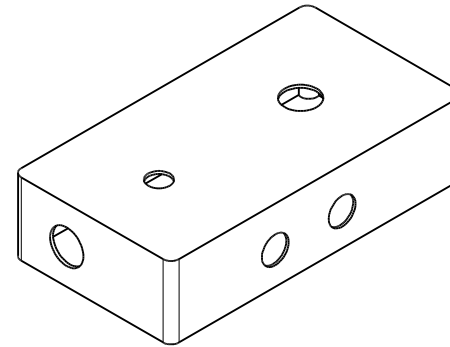
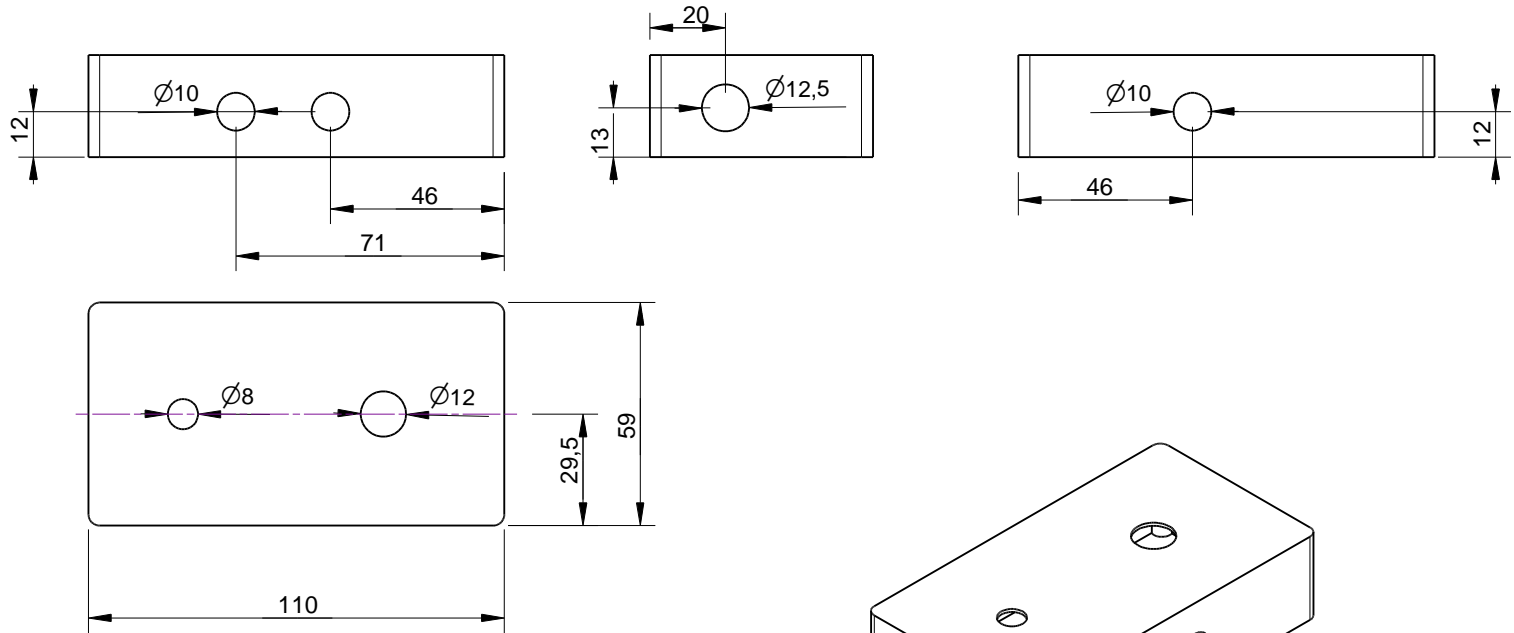

B 1 FS, 3 Jacks, 1 LED

Edition

Sheet

1

2

3

4

5

6