

1

2

3

4

5

6

RevNo

Revision note

Date

Signature

Checked

A

A

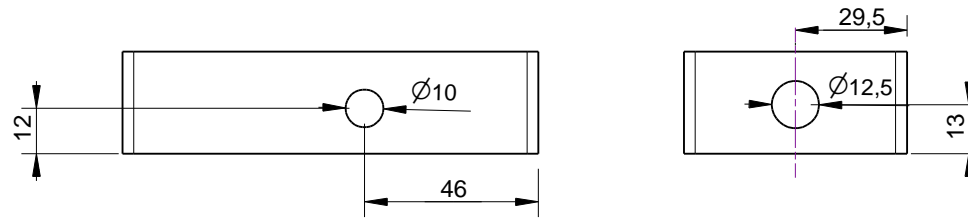

B

B

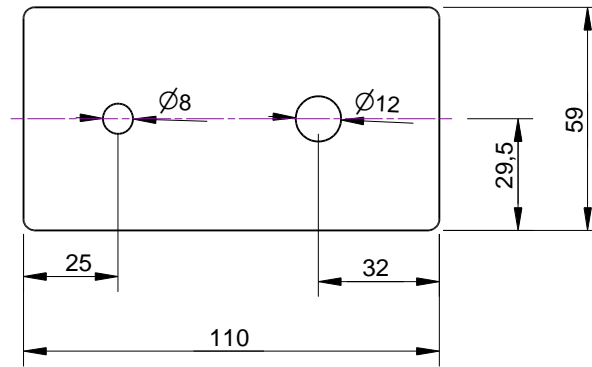

C

C

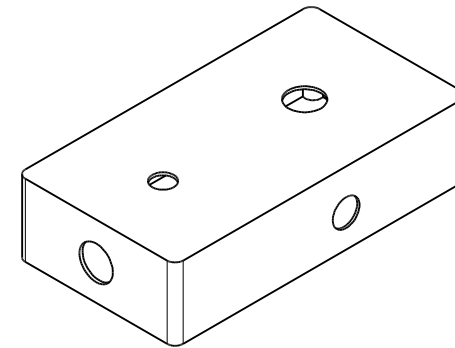

D

D



B 1Fs, 2 Jacks, 1 LED

Edition

Sheet

1

2

3

4

5

6