

1

2

3

4

5

6

RevNo

Revision note

Date

Signature

Checked

A

A

B

B

C

C

D

D

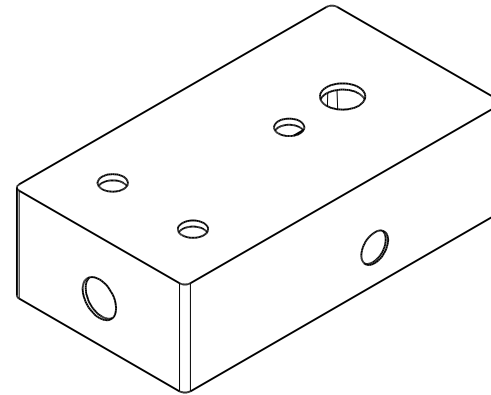
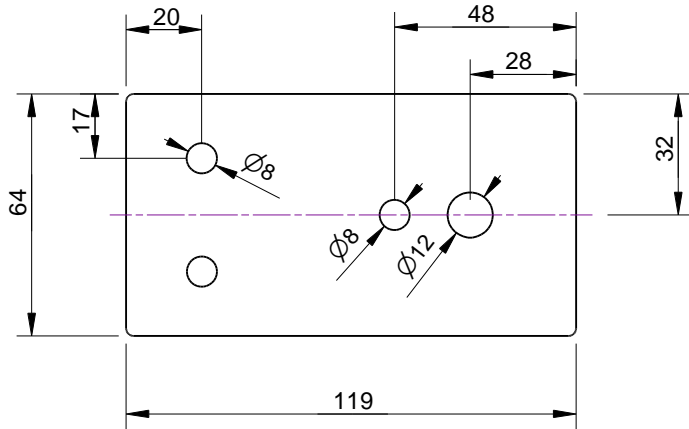
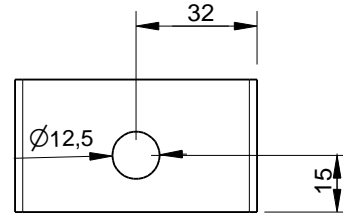
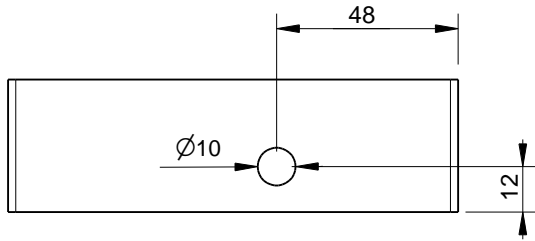

125B 2 Potentiometer



Edition

Sheet

1

2

3

4

5

6